

REVISION HISTORY			
REV.	DESCRIPTION	DATE	APPROVED
A	REDRAWN w/o CHANGE	09/21/2009	KAH

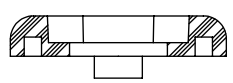
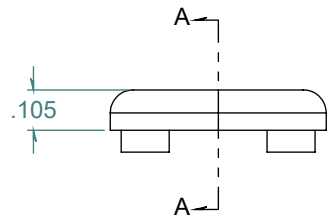
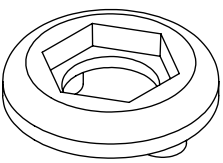
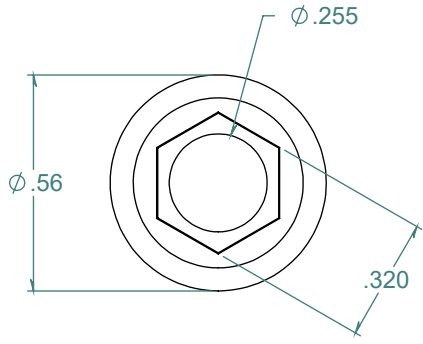

SECTION A-A
SCALE 2 : 1

DIMENSIONS ARE IN INCHES UNLESS SPECIFIED. TOLERANCES ARE:
 FRACTIONS +/- .015
 2 PLACE DECIMAL +/- .010
 3 PLACE DECIMAL +/- .005
 ANGLES NOTED

ARK-PLAS PRODUCTS, INC.

LKA76-NY6
CODING RING

FREE SAMPLES ARE AVAILABLE FOR TESTING. CONTACT CUSTOMER SERVICE

MATERIAL:
NYLON, YELLOW

FINISH:
RMS 109.2

SIZE A	JOB # MP295	DRAWN BY: <i>KAH</i>	REV. LEVEL
	SCALE: 2:1 DO NOT SCALE DRAWING	SHEET 1 OF 1	A

PROPRIETARY AND CONFIDENTIAL
 THE INFORMATION CONTAINED IN THIS DRAWING IS THE SOLE PROPERTY OF ARK-PLAS PRODUCTS, INC. ANY REPRODUCTION IN PART OR AS A WHOLE WITHOUT THE WRITTEN PERMISSION OF ARK-PLAS PRODUCTS, INC. IS PROHIBITED.